

CONFOCAL APPLICATION LETTER

reSOLUTION

Triggering with the Leica TCS SP5, TCS SP5 II and DM6000 CFS –
an Application Guide

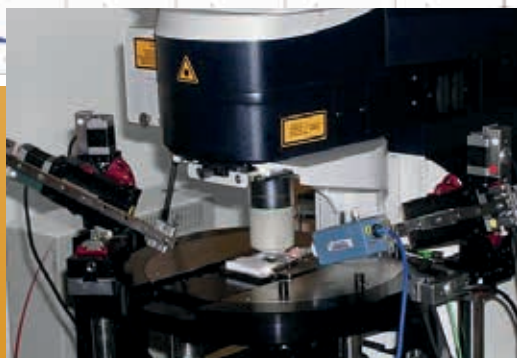
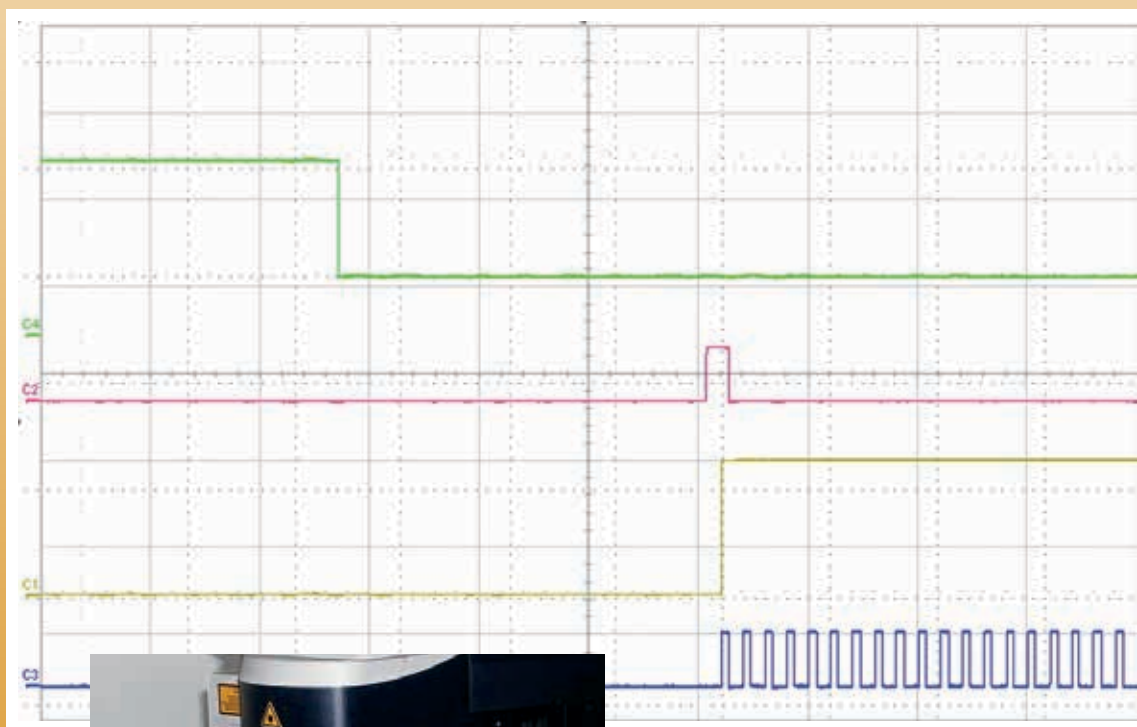

Contents

1	Introduction	3
2	The Leica Trigger Unit	4
2.1	Trigger unit – pins on the front	4
2.2	Trigger unit – pins on the back	5
3	Trigger Timing	6
3.1	Timing for trigger in	6
3.2	Timing for trigger out	6
4	Rising or Falling Edge of the Trigger Pulse	7
5	How to Configure Triggers with LAS AF Software	8
6	Input Triggers	8
6.1	Wiring diagram for input triggering	9
6.2	Range of function for applications with input triggering	10
6.2.1	Trigger in at the beginning of a time lapse experiment	10
6.2.2	Delayed input trigger	11
6.2.3	Delayed and repeated input trigger	12
6.2.4	Triggering of each frame	13
7	Output Triggers	14
7.1	Wiring diagram for output triggering	14
7.2	Range of function for applications with output triggering	15
7.2.1	Trigger out at the beginning or end of a time lapse experiment	15
7.2.2	Delayed output trigger for xyt-series	16
7.2.3	Repeated output trigger pulses for xyt-series	17
7.2.4	Delayed and repeated output trigger pulses for xt-series	18
	Appendix	
	I. Functional range of the trigger unit	20
	II. Connectors and explanations	21

1 Introduction

Communication between instruments is crucial in physiological experiments to coordinate image acquisition and physiological measurements. A common method for synchronizing imaging and electrophysiological measurement devices is the use of trigger signals.

Triggering devices provide voltage signals used to generate a notification to external devices. The trigger signal can be represented by the rising or falling edge of a voltage change, i.e., a pulse, the logic combination of two signals, or a certain level that will release a trigger signal when it falls below or exceeds. In an experimental setup, there is always a reference system. The trigger signals are named according to the reference system, which is the Leica TCS SP5.

All trigger signals that leave the reference system are called **trigger out signals** or output triggers. Trigger signals coming from a different instrument and going into the reference system are called **trigger in signals** or input triggers (Fig. 1). In most cases trigger in and trigger out signals are very short voltage changes going from 0 to 5 V. A 5 V. A trigger signal is also referred to as – a Transistor-Transistor Logic (TTL) pulse.

This document provides detailed information about triggering with the Leica TCS SP5, TCS SP5 II and DM6000 CFS systems.

Examples of TCS SP5 triggering situations include transferring line and frame start information of the TCS SP5 to counting electronics (FLIM), and synchronization of optical imaging and electrophysiological measurements (Fig. 2 and 2a).

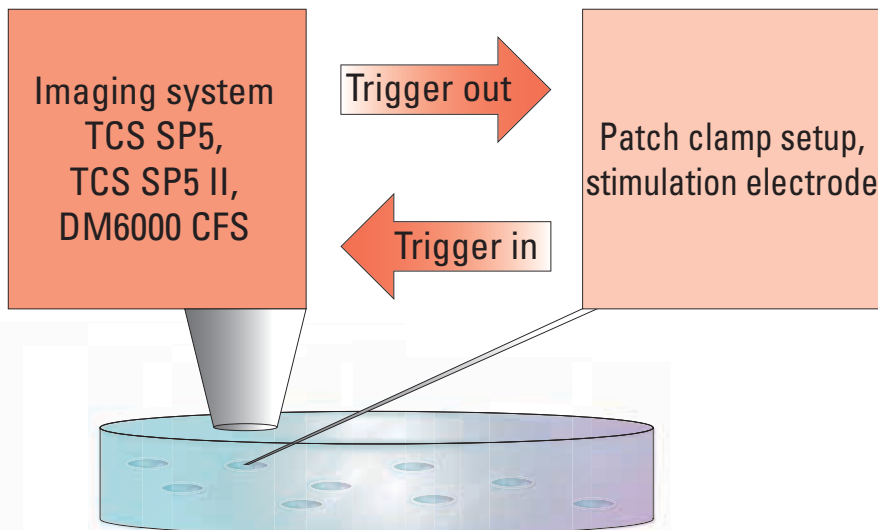

Fig. 1: Communication between instruments by triggering: The Leica TCS SP5 is the “reference system”: Trigger signals leaving the TCS SP5 are called trigger out signals; trigger signals going into the TCS SP5 are called trigger in signals.

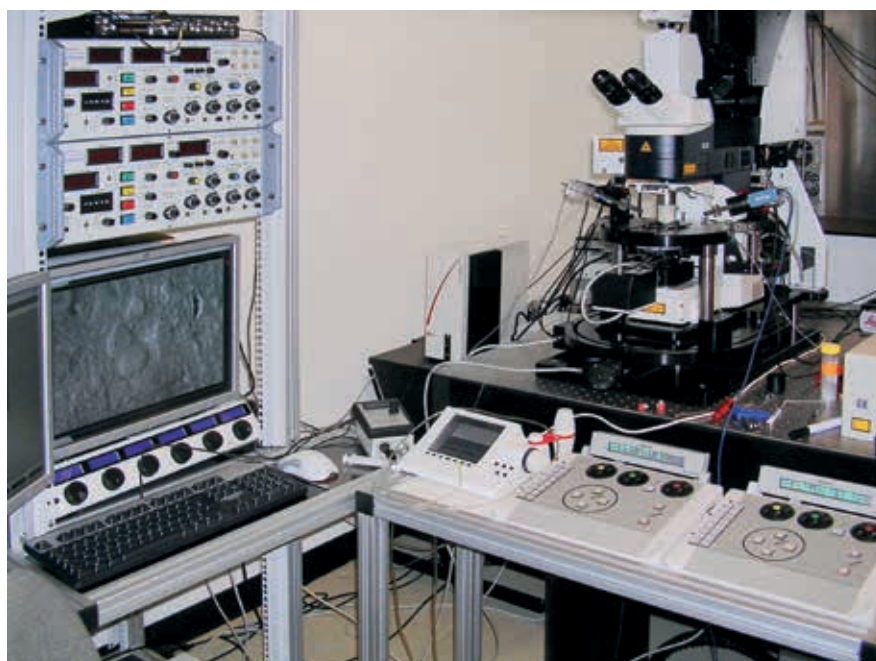

Fig. 2: A typical setup for electrophysiology: triggering is used to synchronize data acquisition with electrical stimulation.

Courtesy: Dr. Thomas Nevejan, Institute of Physiology, University of Bern, Switzerland

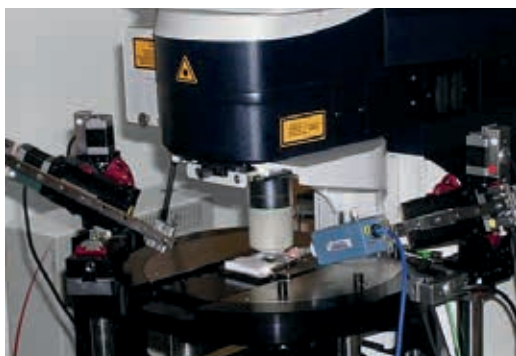

Fig. 2a: Detail of Fig. 2 showing the objective lens for optical imaging, the mini-chamber for keeping the brain slice under physiological conditions, and the stimulation electrode at the blue holder.

2 Leica Trigger Unit

For triggering with the Leica TCS SP5, TCS SP5 II and a DM6000 CFS, a device is needed that acts as a physical interface between the SP5 scan head and the external instrument(s). This device, called Leica trigger unit, is a mandatory piece of equipment for triggering applications.

The following section describes the functional range of all connectors on the trigger unit.

2.1 Trigger unit – pins on the front



Fig. 3a: Front of trigger unit

1 Sync In 50 Ohm:

“Sync In 1 and 2” can be used for the synchronization of the TCS SP5 scanner with pulsed lasers such as the MP lasers (80 MHz pulse repetition rate) used for FLIM, STED. Pulses of the Sync In go to the scan electronics.

2 Trigger In 1 and 2:

With these two pins the trigger unit can receive input trigger signals (Trigger In) of 0 V to 5 V (TTL) – the signals are transferred to the scan head to start scanning. The signal needs 1 μ sec transfer time from the trigger unit to the scan head.

Maximum input voltage for trigger in is 5.5 V – no matter if the external power supply is used or not. The use of higher voltages will damage the trigger unit!

These triggers can be freely configured within the LAS AF software tools Live Data Mode and Electrophysiology. The triggers are configured within the **Trigger Settings** window (see section 6, page 8).

The Trigger In 1 and 2 operate in xyt-scan as well as in xt-scan mode. Upon activation of the xt-scan mode, the xt-dialog shows pages. For the definition of triggers, pages are handled equivalent to frames.

Example: if a page is composed of 512 lines and a trigger in is set to repeat every single frame, the system scans 512 lines (= 1 page) when 1 trigger arrives.

3 Trigger Out:

Common characteristics of trigger out signals 1 – 8

The signals are generated in the scan head. The refresh rate of these ports is 1 MHz. The signal needs 1 μ sec transfer time from the scan head to the external instrument. The ports are electrically isolated from the scanner.

Voltage range for trigger out:

The IO/standard is LVTTTL (0 V...3.3 V) without external power supply, and TTL (0 V...5 V) when an external power supply for the trigger unit is used.

Trigger Out 1 – 4 are freely configurable in the LAS AF software tools Live Data Mode and Electrophysiology. The triggers are configured within the **Trigger Settings** window (see section 7, page 14).

Trigger Out 5 – 8

These standard trigger out signals are created independently from any application. They are automatically created in the scan head.

Trigger Out 5

This signal is sent out from the scan head whenever the scanner is active; it is automatically generated.

For the Leica DM6000 CFS (electrophysiology-system) it is used as a sample clock for the National Instruments Data Acquisition box.

Trigger Out 6 and 7 are automatically created in the scan head: frame trigger (Trigger Out 6), and line trigger (Trigger Out 7).

These standard trigger out signals are created independently from any application.

They can be used to monitor the scanning process in the LAS AF software via the Data Acquisition (DAQ) box, by an oscilloscope, or by external instruments and software, e.g., Axon Instruments.

For electrophysiological applications they can be used to visualize the line- and frame-scanning in combination with recorded voltage data, etc.

Trigger Out 8

This signal is an automatically generated out trigger; a frame trigger needed for the ROI spectrometer.

It is used with Leica DM6000 CFS to trigger the data acquisition start. Therefore, it needs to be connected to the National Instruments Data Acquisition box.

4 Sync Out 1, Sync Out 2:

Sampling/Refresh rate is 40 MHz,
Sync Out 2 is the pixel clock – the clock generator for scanning.

2.2 Trigger unit – pins on the back

5 Optional Trigger I/O:

Provides several additional signals via D-SUB pin.

Maximum input voltage 3.3 V.

Higher voltages will damage the trigger unit!

With external power supply the maximum input voltage is also 3.3 V.

Sampling/Refresh rate is 1 μ sec;
4 additional inputs (Trigger In) can be configured within the LAS AF **Trigger Settings** window.
The user has to build up an own adapter to get access to these triggers.



Fig. 3b: Back of trigger unit

6 Trigger Out – Sync Out NIM and Sync Out

50 Ohm:

Very fast output triggers (40 MHz).

7 Opt DC In:

It is the connector (see arrow) for an external power supply and for optional use. It enables the user to get a 5 V trigger signal out.

Without an external power supply the trigger unit can receive triggers of max. 3.3 V (Trigger In 1 and 2). It can send out triggers (Triggers Out 1 – 8) of max 3.3 V.

Using an external power supply the trigger unit can receive triggers of max. 5 V (Trigger In 1 and 2). It can send out triggers (Triggers Out 1 – 8) of max 5 V.

Note: The indication “12 V” refers to the scan head trigger unit connection described in 8.

8 Connector Scan Head/Triggerbox:

This pin is used to connect the scan head to the trigger unit. The trigger unit needs to be connected to the scan head to pass trigger signals to the trigger unit and vice versa. In addition, the trigger unit gets 3.3 V from the scan head. The trigger unit can be used with or without an external power supply.

3 Trigger timing

3.1 Timing for trigger in

The scan starts after an incoming trigger is associated with the movement of the scanning mirrors. The image acquisition starts when the scanning mirrors have reached their proper positions for scanning.

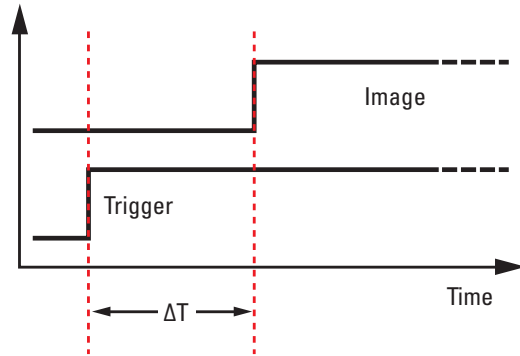

Fig. 4: ΔT is the needed time duration from the beginning of a trigger pulse to the scan start.

The needed time duration (ΔT) from the arrival of a trigger pulse at the Leica TCS SP5 to the scan of the 1st image pixel is constant for a given scan format. It depends on the scan speed and on the scanning mode (uni- or bi-directional). Therefore, the ΔT can be very precisely predicted (Fig. 5).

In addition to the ΔT , a little time is required to position the second scanning mirror (x). This time duration cannot be predicted and therefore is a jitter. The maximum jitter time that is required is equal to the time needed to scan one line (for 1000 Hz = 1 ms).

However, input triggers react very fast and are reproducible. Without considering the little jitter, the reproducibility is within 10 μ s.

3.2 Timing for trigger out

The different types of available output trigger signals have a different timing characteristics:

1. Trigger out on frames (free configurable by the user for xy- and xt-scanning mode via the LAS AF user interface) and line and frame trigger out (automatically generated):

These triggers have no delay since they are exactly synchronized with the position of the x-scan mirror.

2. Trigger out on function start/end:

These triggers are software-controlled and cannot be predicted as the input triggers.

Fig. 5: Table of ΔT for input triggers on Leica TCS SP5 systems. Data in ms.

ΔT for input triggers SP5-Systems (ms)										
	Pixelformat									
Scan Speed (Hz) unidirectional (bidir)	16	32	64	128	256	512	1024	2048	4096	8192
100 (200)	320 (160)	620 (310)	100 (50)	100 (50)	100 (50)	100 (50)	100 (50)	–	–	–
200 (400)	160 (80)	310 (155)	50 (25)	50 (25)	50 (25)	50 (50)	50 (50)	–	–	–
400 (800)	80 (40)	155 (77.5)	25 (15)	25 (17.5)	25 (15)	25 (15)	25 (15)	25 (15)	25 (15)	40 (15)
700 (1400)	45 (22.8)	88.5 (44.2)	17.1 (15.7)	17.1 (15.7)	17.1 (15.7)	17 (15)	17 (15)	–	–	–
1000 (2000)	32 (16)	62 (31)	16 (16)	16 (15)	16 (15)	15 (15)	15 (15)	15 (15)	–	–
1400 (2800)	22.9 (11.4)	44.3 (22.1)	15.7 (15)	15.7 (15)	11.4 (15)	17 (15.7)	17 (15.7)	17 (15.7)	–	–
Resonant Scanner 8000 (16000)	4 (2)	7.7 (3.87)	2 (1.65)	2.5 (1.87)	3.75 (2.37)	5.75 (3.5)	10.25 (5.62)	–	–	–

4 Rising or Falling Edge of the Trigger Pulse

Triggering with the Leica TCS SP5, TCS SP5 II, and DM6000 CFS is controlled by the “edges” of the trigger pulses – falling or rising edges. The hardware that should be triggered must recognize the voltage change from high to low and vice versa.

By default, the Leica TCS SP5 uses a falling edge for the trigger in signals (Fig. 6, red arrow at green trace). The time delay (ΔT) between the arrival of an external trigger in signal and the scan start can be demonstrated when frame or line triggers are simultaneously recorded (Fig. 6: yellow and blue traces in graph). These trigger signals are automatically created by the TCS SP5 and can be visualized to monitor the scanning process.

The control for triggering by a rising or falling edge of trigger pulses can be defined in the LAS AF software. In **Configurations**, a click on **EP/Trig** opens a window for **Trigger Settings** (Fig. 7). Here, a list is displayed with all freely configurable triggers. The edge of the pulse is referred to as the **Pulse Form**: low = falling edge, high = rising edge. The default trigger setting is at **Low** (falling edge) for all triggers. Just click on **High** to select for rising edge.

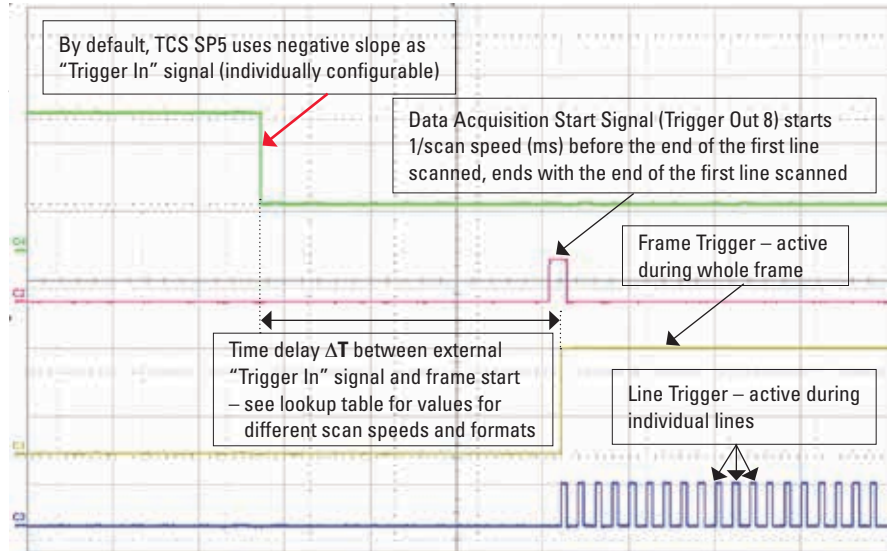

Fig. 6: Triggering with the Leica TCS SP5 showing 4 traces of trigger signals measured and displayed on a 4-channel oscilloscope. Description of traces:

- Green: Trigger In 1 from function generator;
- Red: Trigger Out 8, signal for data acquisition start for the Data Acquisition Box on a Leica DM6000 CFS system;
- Yellow: Trigger Out 6 from trigger unit, automatically generated frame trigger;
- Blue: Trigger Out 7 from trigger unit, automatically generated line trigger

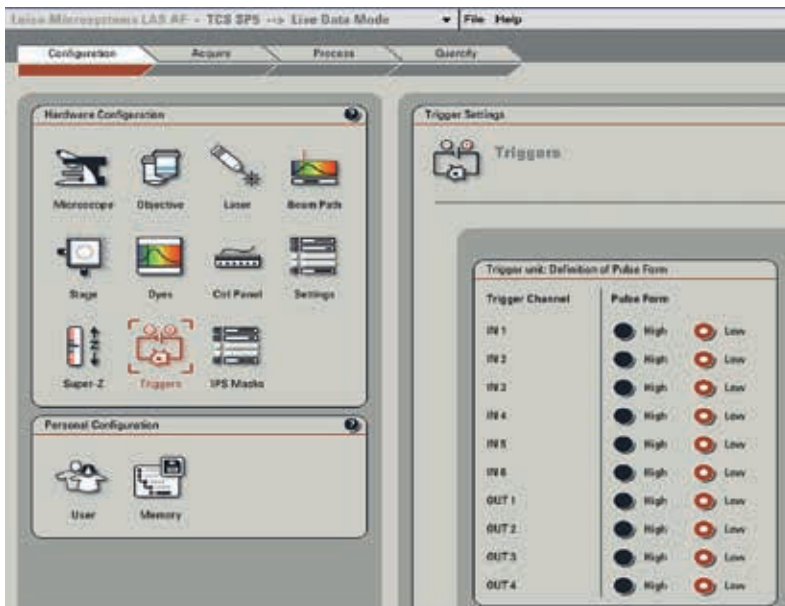

Fig. 7: Trigger settings in LAS AF to define the control for triggering by a rising or falling edge of trigger pulses. A list is displayed with all freely configurable triggers. The edge of the pulse is referred to as the Pulse Form: low = falling edge, high = rising edge.

5 How to Configure Triggers with LAS AF Software?

This section describes the different trigger capabilities that can be performed with the Leica TCS SP5, TCS SP5 II, and DM6000 CFS. There are three prerequisites for triggering applications:

1. The system must be equipped with the Leica trigger unit.
2. Trigger cables need to be present.
3. The software license for the Electrophysiology tool or for the Live Data Mode must be active. Within one of these tools, triggers can be assigned.

After the definition of one or several Jobs within Electrophysiology or Live Data Mode, a Job must be selected to which a trigger should be assigned. By a click on that Job and a subsequent right mouse click a list of options opens (Fig. 8). By selecting **Trigger**, and the **Trigger Settings** window (Fig. 9) opens.

The **Trigger Settings** window (Fig. 9) allows input (**Trigger In**) and output triggers (**Trigger Out**) to be set. Different options are available, including triggering within xt-scans. A defined trigger is automatically assigned to the selected Job.



Fig. 8: Options for Job handling.

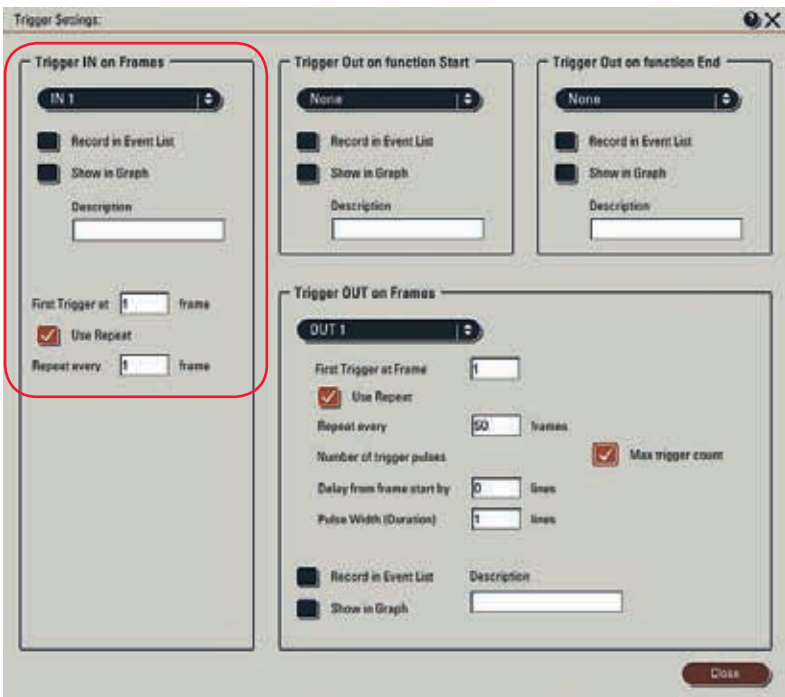

Fig. 9: **Trigger Settings** window. The area for definition of input triggers is bordered. Details are described below.

6 Input Triggers

A signal from an external device is used to trigger the start of the data acquisition with Leica TCS SP5. This approach is required to synchronize data acquisition and stimulation of neurons by a microelectrode pipette. With Leica LAS AF software two input triggers can be freely configured for these applications – trigger **IN 1** and trigger **IN 2**.

To assign an input trigger to a job, the appropriate trigger channel has to be selected from the drop down list within the **Trigger Settings** window (Fig. 9), e.g., **IN 1**.

6.1 Wiring diagram for input triggering

By using the two trigger in pins the trigger unit can receive input trigger signals of 0 V to 5 V (TTL) from an external device. The signals from the external instrument are then transferred to the scan head to synchronize the scan start. Usually, scanning is triggered through an output signal of an external device. Thus, the D/A output of the external instrument needs to be connected to the Trigger In pin (Trigger In 1 or Trigger In 2) of the trigger unit (Fig. 10 and Fig. 11).

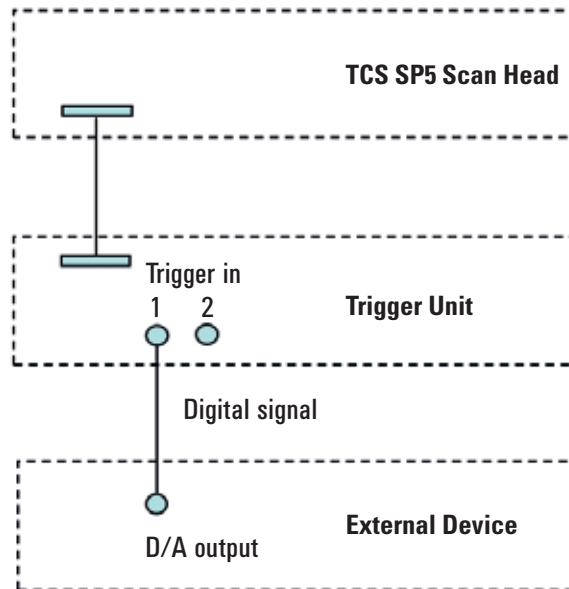

Fig. 10: Wiring for input triggering

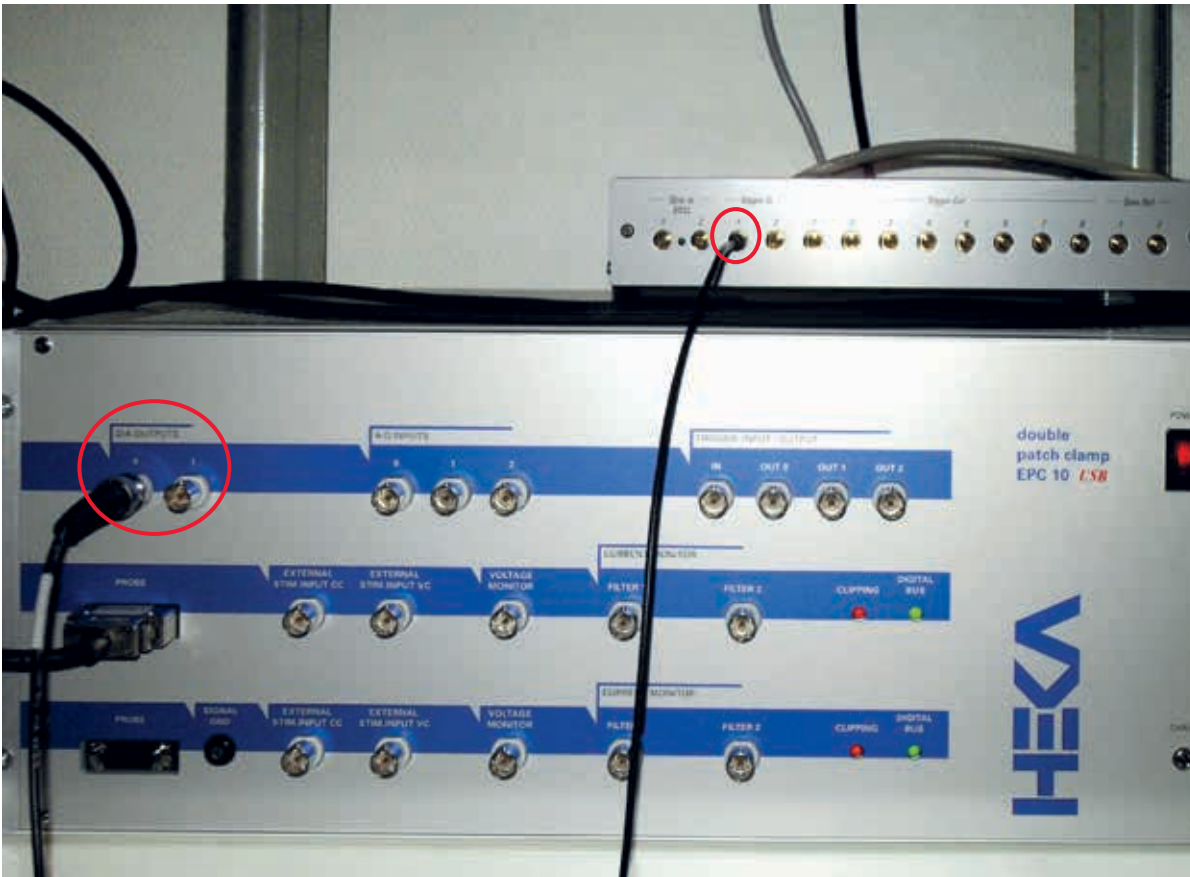

Fig. 11: Trigger In: The scan start of the Leica TCS SP5 is triggered by an incoming trigger signal from a patch clamp amplifier (DA output signal). The analog output of the patch clamp amplifier is connected to the Trigger In 1 pin of the trigger unit.

6.2 Range of function for applications with input triggering

This section gives an overview on the different options for input triggering. A schematic of the experimental design, a description of the **Trigger Settings** window in LAS AF, the resulting user interface, and the quantification chart after execution of the experiment are described.

6.2.1 Trigger in at the beginning of a time lapse experiment

This option is valid for all experiments in physiology that need to synchronize the scan start with the action of an external instrument. For example, a TTL signal from a patch clamp system is sent for triggering the scan start at the beginning of a time lapse experiment (Fig. 12A). Here the option **Trigger IN on Frames** has to be set in the LAS AF **Trigger Settings** window (Fig. 12B). Then the trigger is displayed in the software interface (Fig. 12C). This trigger option works in the xyt and yt scanning modes. The resulting quantification chart shows that the scanning starts after the arrival of the input trigger (Fig. 12D, arrow).

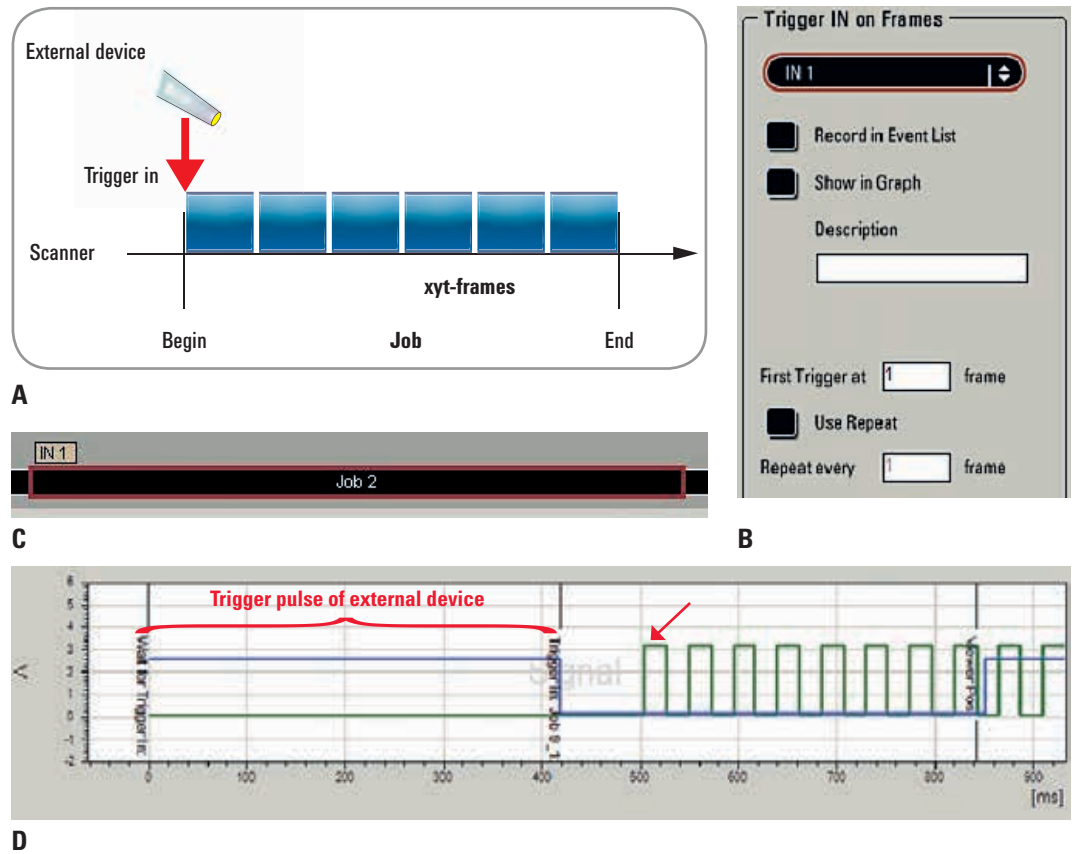

Fig. 12: Trigger in at beginning of a time lapse experiment (Job):

A: Schematic of experimental design for an input trigger received at the beginning of a Job to start the scanning process.

B: Settings in the **Trigger Settings** window of LAS AF for the experiment described in A.; Selection of the trigger option **Trigger IN on Frames** and trigger **IN 1** from the list.

C: Indication of the trigger **IN 1** at the start of the assigned Job in the time line of the Electrophysiology or Live Data Mode tool of LAS AF.

D: Chart after execution of the experiment. Blue: Trigger signal, Green: Frame triggers (Trigger Out 6) are recorded to monitor the scanning process.

6.2.2 Delayed input trigger

When cells or neuron dendrites have to be observed without any stimulation for some time before a stimulation pulse is sent, a delayed input trigger can be defined. This trigger option works in the xyt and xt scanning modes. The arrival of the input trigger, e.g., from a stimulation electrode, has to be defined in **First trigger at ... frame** in the field **Trigger IN on Frames** in the **Trigger Settings** window (Fig. 13B).

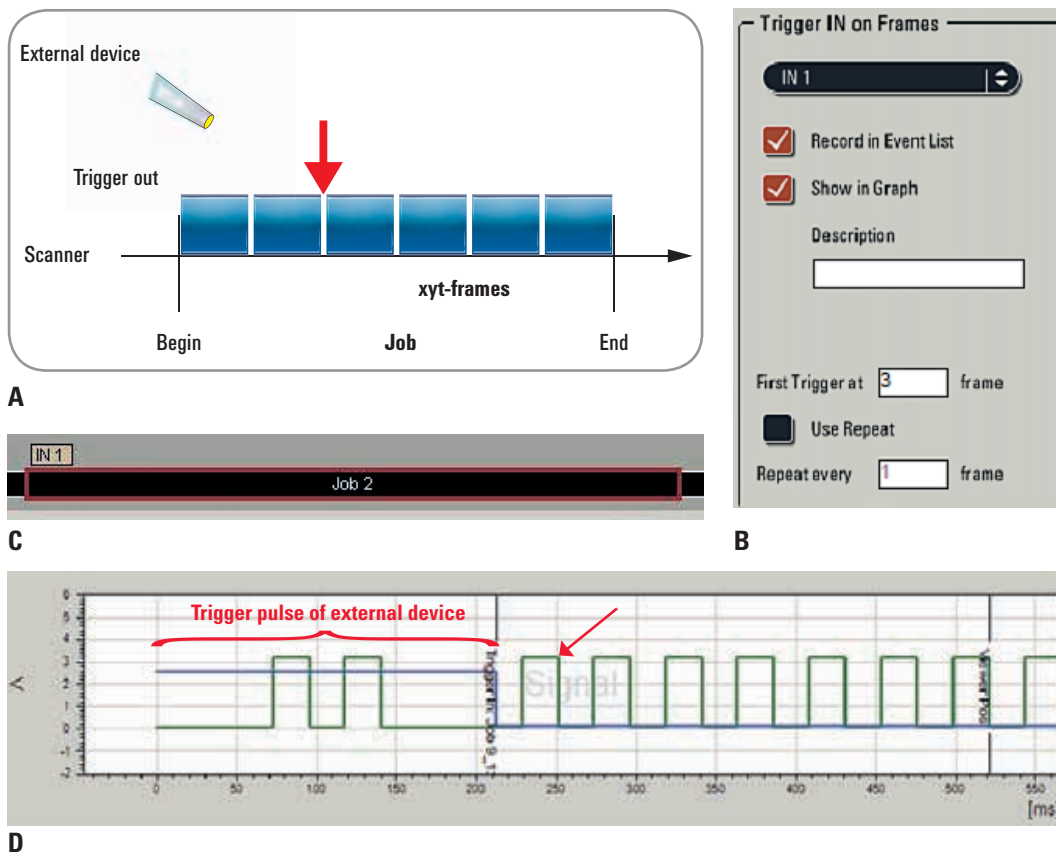

Fig. 13: Delayed input trigger for continuing the scanning process:

A: Schematic of experimental design for an input trigger after a delay of 2 frames.

B: Settings in the **Trigger Settings** window of LAS AF for the experiment described.; Selection of trigger **IN 1** from the list in the field **Trigger IN on Frames** using the option **First Trigger at ... frame** for the delayed triggering.

C: Indication of the trigger **IN 1** at the start of the assigned Job in the time line of the Electrophysiology or Live Data Mode tool of LAS AF. Delay is not indicated.

D: Chart after execution of the experiment. Blue: Trigger signal, Green: Frame triggers (Trigger Out 6) are recorded to monitor the scanning process. Note that scanning is continued after the 3rd frame upon the arrival of the trigger pulse.

6.2.3 Delayed and repeated input triggers

The scanning process can be triggered upon the arrival of repeated trigger signals at the Leica TCS SP5. Thus, scanning is performed for a defined number of frames only when a trigger signal arrives. This trigger option works in xyt and xt scanning modes. The arrival of the first input trigger has to be defined in **First trigger at ... frame** in the field **Trigger IN on Frames** in the **Trigger Settings** window (Fig. 14B). In addition, the repetition frequency has to be set in **Repeat every ... frames**.

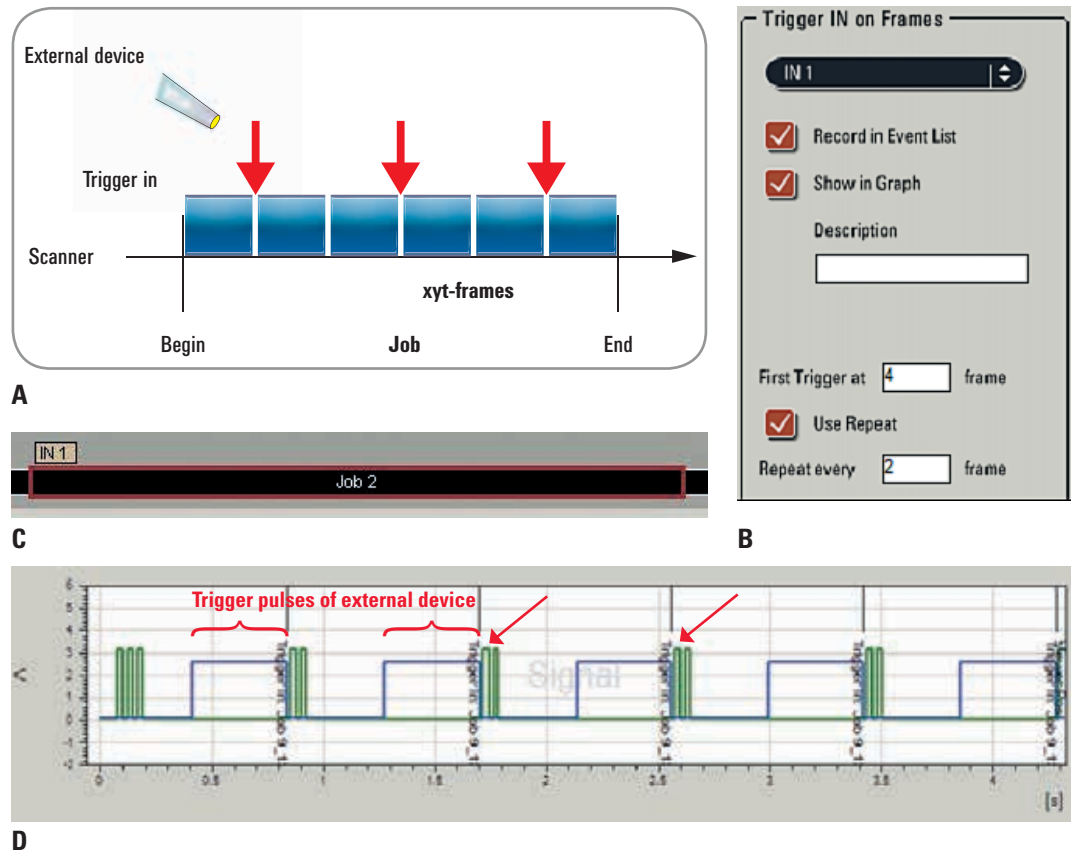

Fig. 14: Delayed and repeated input triggering:

A: Schematic of experimental design for several input triggers after a delay.

B: Settings in the **Trigger Settings** window of LAS AF for the experiment described. Selection of trigger **IN 1** from the list in the field **Trigger IN on Frames** using the options **First trigger at ... frame** for the delayed triggering, and **Repeat every ... frames**.

C: Trigger **IN 1** at the assigned Job in the time line of the Electrophysiology or Live Data Mode tool of LAS AF. Delay and repeat is not indicated.

D: Chart after execution of the experiment. The scanning process (green graph) is started after the 4th frame upon the arrival of the trigger pulse (blue graph). Scanning is repeated after the arrival of trigger signals at every 2nd frame. Frame triggers (Trigger Out 6) are recorded to monitor the scanning process.

6.2.4 Triggering of each frame

Some applications, such as the synchronization of the scanning process with the heartbeat of a mouse, require that every frame to be scanned is triggered by an incoming trigger signal. The arrival of the first input trigger has to be defined in **First trigger at ... frame** in the field Trigger IN on Frames in the **Trigger Settings** window (Fig. 15A). This repetition has to be set to 1 in **Repeat every ... frames**.

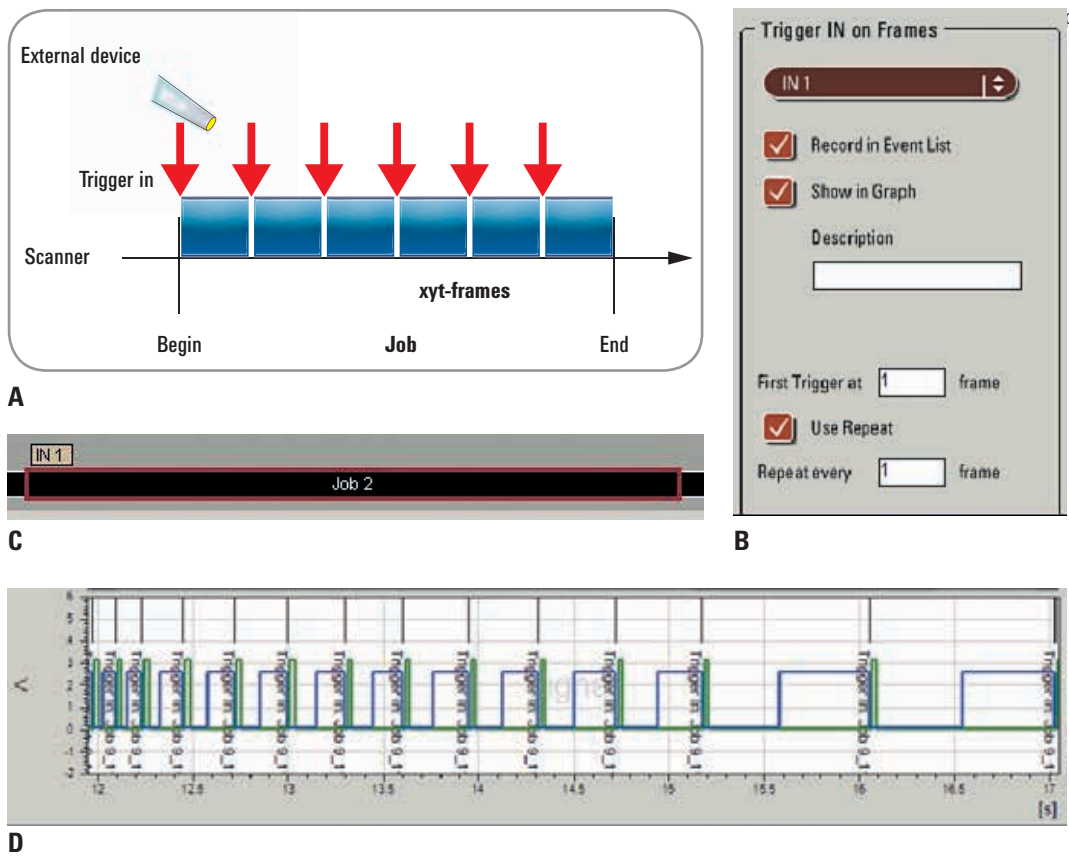

Fig. 15: An incoming signal triggers the scanning of each single frame

A: Schematic of the experiment with triggering for each frame.

B: Description of experiment settings in the **Trigger Settings** window of LAS AF. Selection of trigger **IN 1** from the list in the field Trigger In on Frames using the option **First trigger at 1 frame** and Repeat every 1 frame for triggering of each single frame.

C: Trigger IN 1 at the assigned Job in the Electrophysiology Tool or Live Data Mode.

D: Chart after execution of the experiment. Each single scanned frame (green graph) is triggered upon the arrival of a trigger pulse (blue graph). Trigger Out 6 is used for monitoring the scanning process.

7 Output Triggers

Output triggers are trigger signals that are sent from the Leica TCS SP5 to an external instrument to trigger the action of that external instrument. The trigger signal is sent from the scan head to the external device, e.g., a patch clamp system, to start its operation. With Leica LAS AF software, four Output triggers can be freely configured.

To assign an output trigger to a Job, the appropriate trigger channel has to be selected from the drop down list in within the **Trigger Settings** window, Fig. 16). Four output triggers can be freely configured to start the action of an external device at a defined time point. The software allows assigning a trigger to a certain part of the experiment (Job).

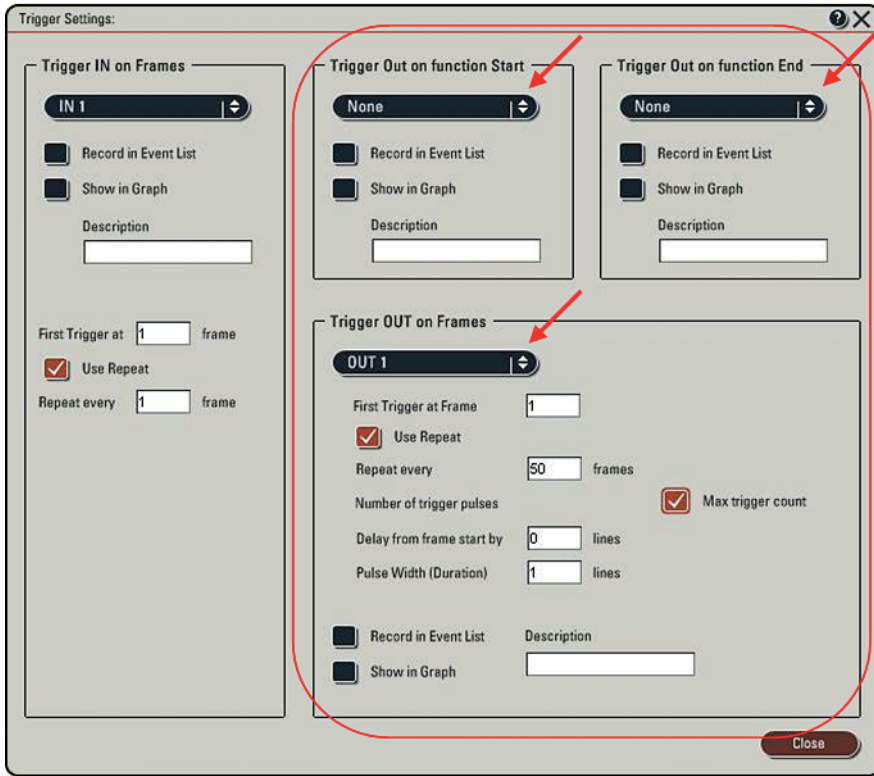

Fig. 16: Options for output triggers are highlighted

Output triggers can be defined at the beginning and the end of a Job or a pause during the experiment and also at a certain delay after the beginning of an experiment. Furthermore, it is possible to send out trigger pulses that start at an arbitrary line within a frame (for xt-scans).

7.1 Wiring diagram for output triggering

Output triggering signals from the Leica TCS SP5 are transferred to the external instrument to synchronize the action of the external instrument with data acquisition. Scanning is triggered through an output signal from the TCS SP5 via the trigger unit (Trigger Out 1, 2, 3, or 4) to the external device. Therefore, the Trigger out pin of the trigger unit needs to be connected with the A/D input of the external instrument (Fig. 17).

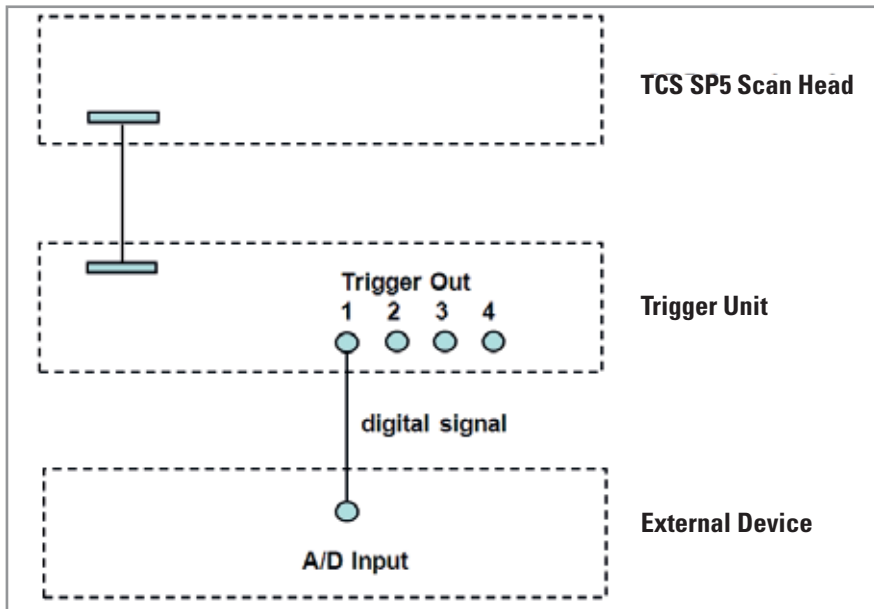

Fig. 17: Wiring for output triggering

7.2 Range of function for applications with output triggering

The following gives an overview on the different application options for output triggering: A schematic of the experimental design, a description of the **Trigger Settings** window in LAS AF, the resulting user interface, and the quantification chart after execution of the experiment are described.

7.2.1 Trigger out at the beginning or end of a time lapse experiment

For experiments that require an output trigger to be sent at the beginning or at the end of the data acquisition, the trigger option **Trigger Out on function Start/End** can be used. Fig. 18 shows the design, LAS AF user interface, and result of such an experiment.

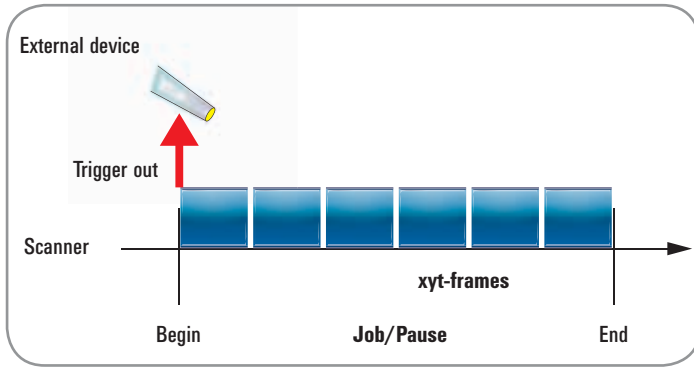

A

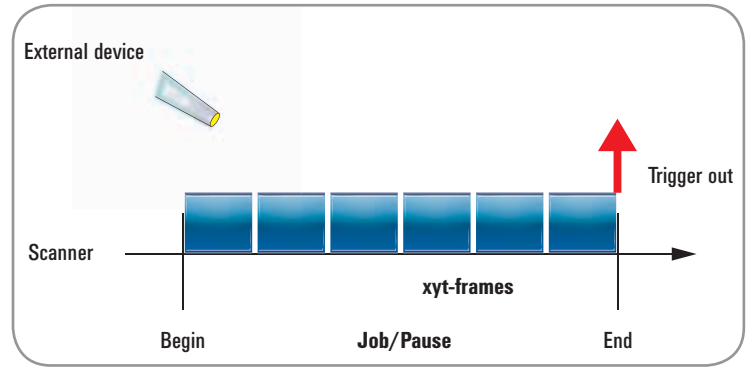

B

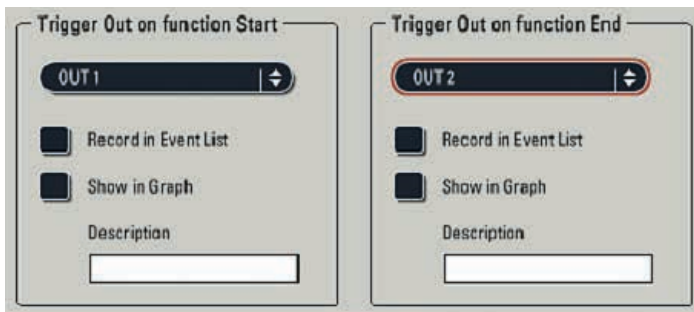

C



D

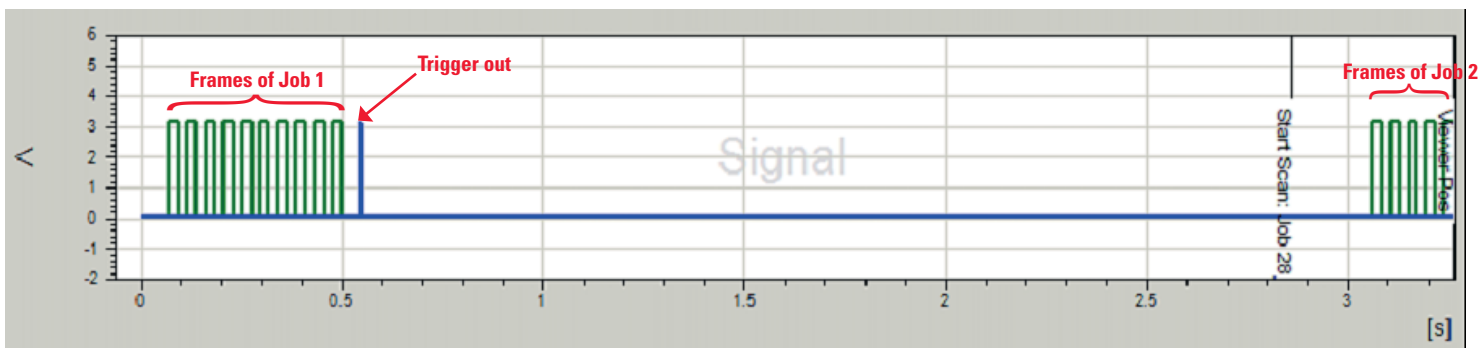

E

Fig. 18: Trigger out at the beginning or end of a Job:

A and B: Schematic of experimental design for an output trigger send at the beginning of a Job (A) or at the end of a Job (B) to start the action of an external device.

C: Settings in the **Trigger Settings** window of LAS AF for the experiment described in A. Selection of the trigger in the field **Trigger Out on function Start/End**.

D: Indication of the trigger out (here, OUT 2) at the end of the assigned Job in the time line in LAS AF; Defined trigger as described in B.

E: Chart after execution of the experiment. Blue: Trigger signal, Green: Frame triggers recorded for monitoring the scanning process. Note: These outputs are software controlled and are not exactly synchronized.

7.2.2 Delayed output trigger for xyt-series

Some experiments in electrophysiology require sending out a trigger pulse at a defined time point after starting the scanning process, e.g., for experiments with delayed electrical stimulation after a defined time of recording the steady state of the non-stimulated cell. For this type of experiment the trigger option **Trigger OUT on Frames** has to be used (Fig. 19).

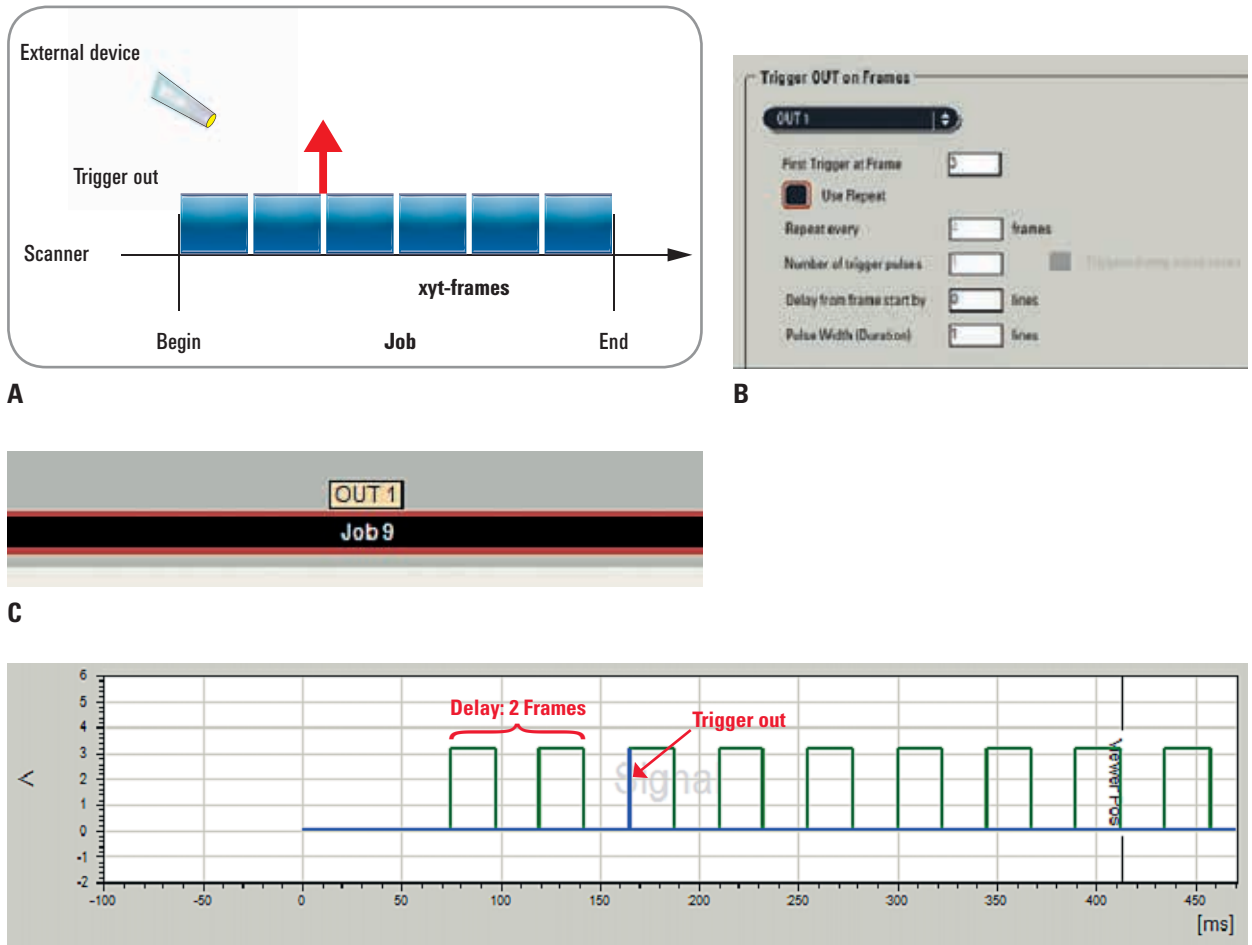

Fig. 19: Delayed output trigger

A: Schematic of experimental design: A delayed output trigger at frame 3 of 10 frames (xyt-series).

B: Settings in the **Trigger Settings** window of LAS AF for the experiment described in A. Selection of the trigger in the field **Trigger OUT on Frames** using the option **First trigger at frame 3**.

C: Indication of the trigger in the LAS AF user interface in Acquire according to the defined trigger as described in B.

D: Chart after execution of the experiment. Blue: trigger signal; green: frame triggers recorded for monitoring the scanning process. Note: The trigger pulse is exactly synchronized with the scanning and has no delay.

7.2.3 Repeated output trigger pulses for xyt-series

For experiments that require frequently sending out a trigger pulse to an external instrument, triggers can be easily configured (Fig. 20). Repeated output triggers are sent starting at a certain frame and repeating at every x number of frames.

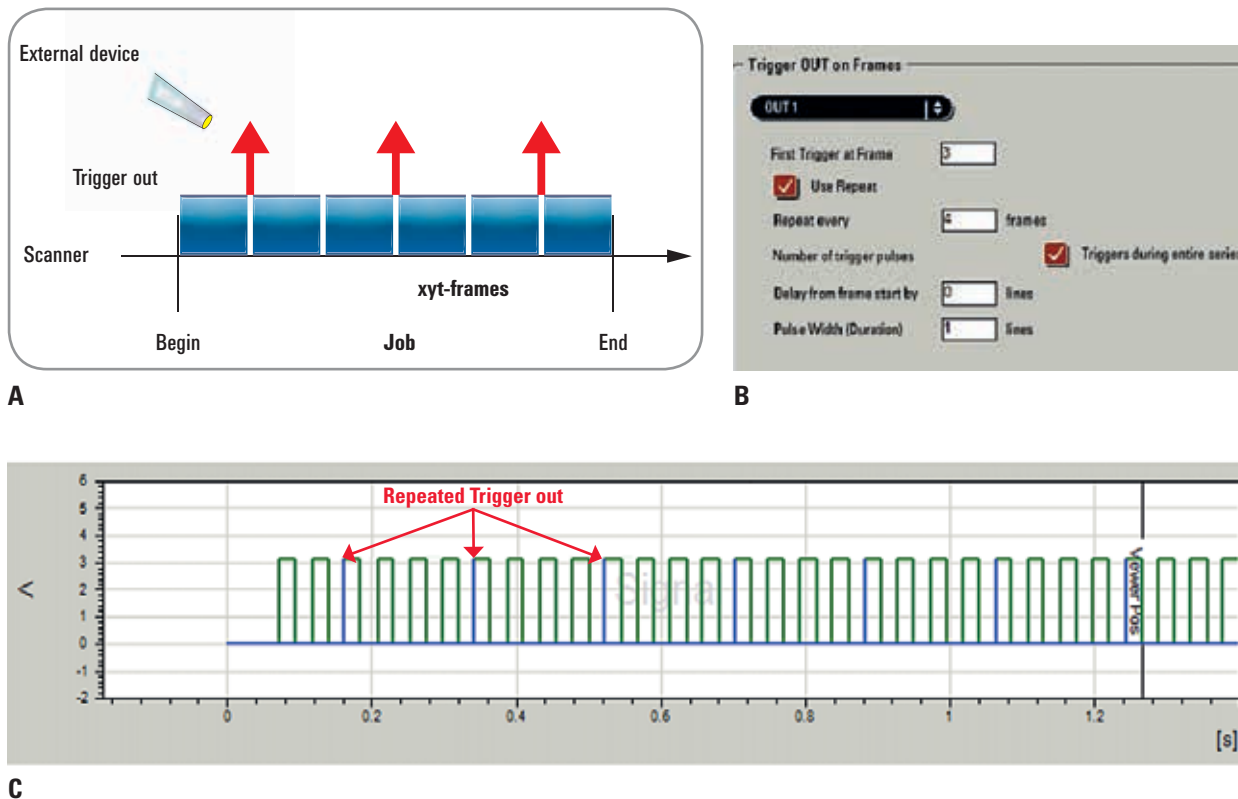

Fig. 20:

A: Repeated output triggers are sent starting at a certain frame and repeating at every second frame (xyt-series, 30 frames) for experiments that require repeated actions of external instruments such as repeated electrical stimulations of a neuron.

B: Trigger setting in LAS AF for the experiment described in A. Selection of the trigger in the field **Trigger OUT on Frames**. The first trigger is set to the 3rd frame. Every 4th frame a trigger pulse is sent out.

C: Chart after execution of the experiment. Blue: Trigger signals, Green: Frame triggers recorded for monitoring the scan process. Note: Trigger pulses are exactly synchronized with the scanning and have no delay.

7.2.4 Delayed and repeated output trigger pulses for xt-series and xyt-series.

In order to follow very fast reactions, e.g., calcium waves and sparks in heart muscle cells, the fastest acquisition mode xt line scan is required. For this scanning mode output triggering can also be used to synchronize scanning and measurement of electrical data.

For output triggers in xt-experiments and xyt-experiments the duration (pulse width) of a trigger pulse can be adjusted. This might be crucial for the proper communication of external devices with the scanner. The pulse duration can be defined by editing a number in **Pulse Width (Duration)**. The delay of the trigger pulse from scan start can be defined by entering a number in **Delay lines from start by** (Fig. 21). Fig. 22 explains how the pulse width is defined by the number of lines. In Fig. 23 the graph of such an experiment is displayed.

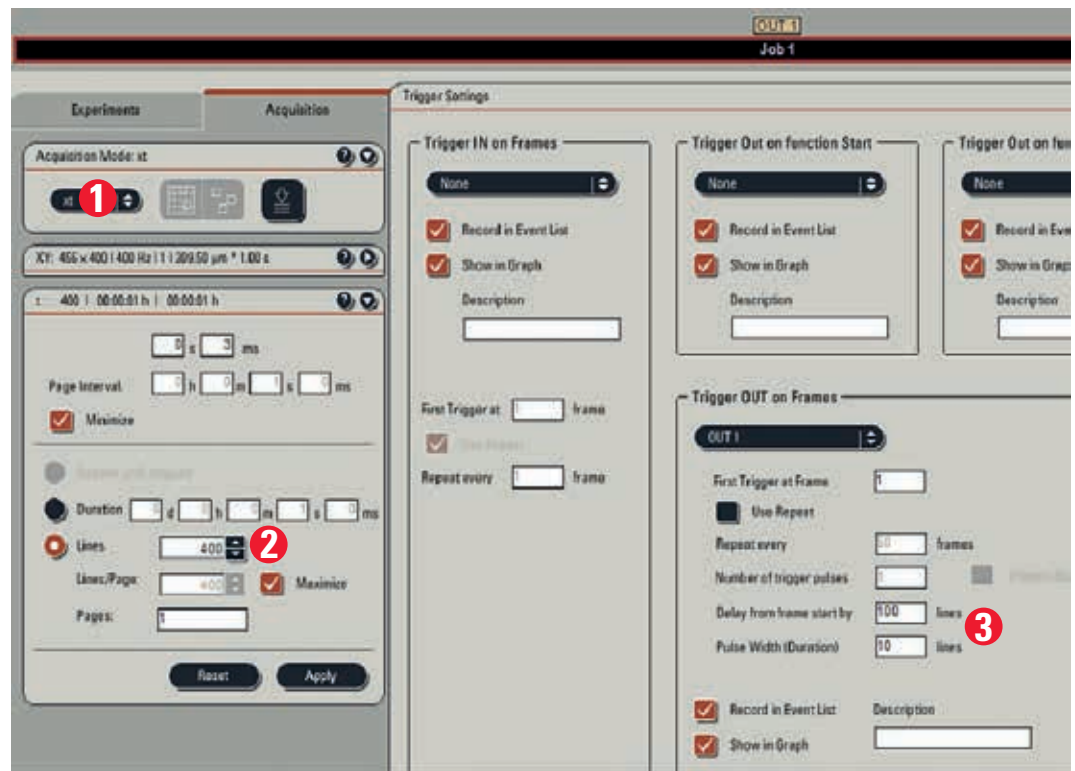

Fig. 21: Trigger setting in LAS AF for an xt-experiment: xt-scan mode is activated (1) and 400 lines in one page is set (2). In the field **Trigger OUT on Frames** a delay from start 100 and duration of the trigger pulse of 10 frames (3) are defined.

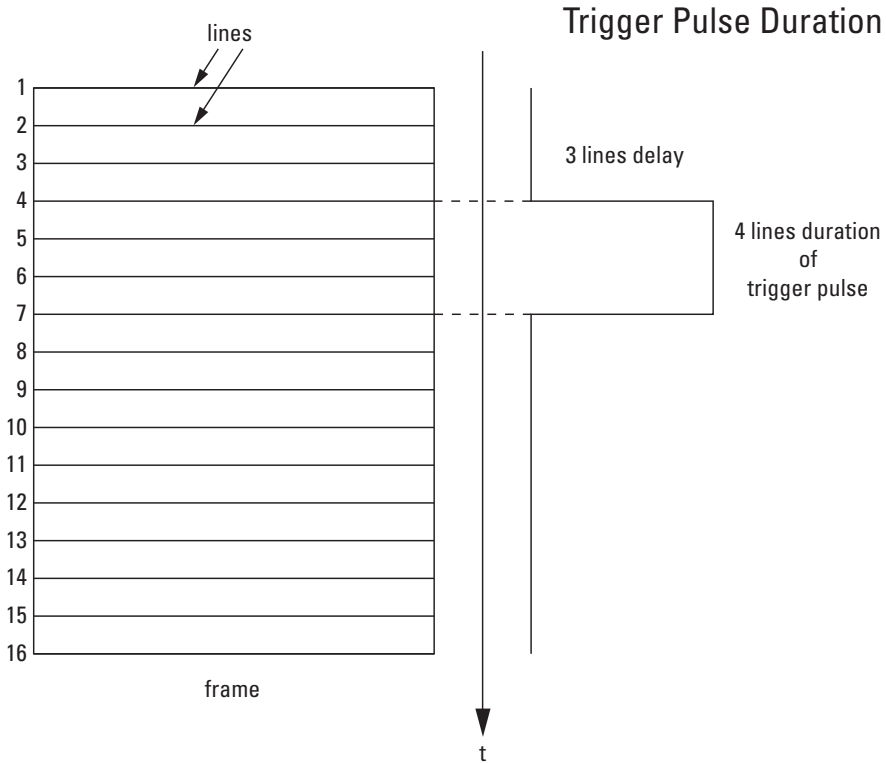

Fig. 22:

Setting trigger pulse duration and delay time by defining lines:
 Each line of a frame needs a defined time to be scanned. Thus, the duration of the trigger pulse can be set via definition of the number of lines. Furthermore, a delay time from the scan start can be set by defining a number of delay lines from frame start.

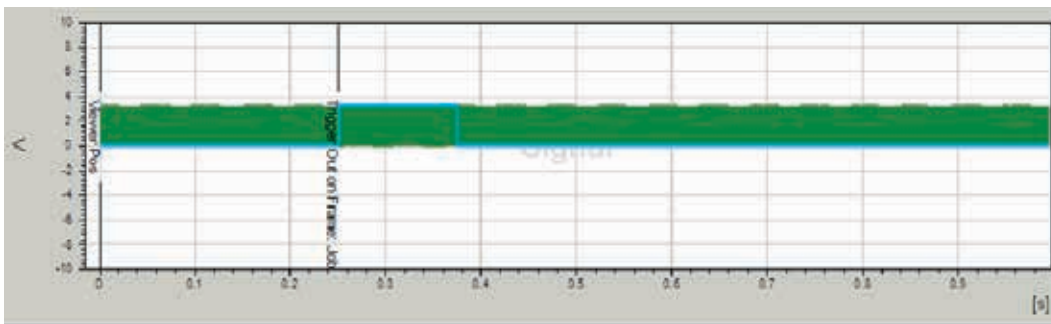

Fig. 23:

Graph of an xt-experiment with triggering (**Trigger OUT on Frames**);
 Blue: Output trigger signal, Delay from start 100, duration 10.
 Green: Line triggers recorded for monitoring the scanning process. Line triggers have a density such that they cannot be discriminated as individual pulses – only by zooming into the graph.

Appendix

I. Functional range of the trigger unit

Connector	Function
Trigger Out 1 Trigger Out 2 Trigger Out 3 Trigger Out 4 Trigger Out 5 Trigger Out 6 Trigger Out 7 Trigger Out 8	<p>Output of trigger signals. The signals are generated in the scan head. The refresh rate of these ports is 1 MHz.</p> <p>The ports are electrically isolated from the scanner.</p> <p>The IO/standard is LVTTTL (0 V...3.3 V) without external power supply and TTL (0 V...5 V) with an external power supply.</p>
Sync Out 1 Sync Out 2	<p>Output of trigger signals. The signals are generated in the scan head and have direct connections to the scan head.</p> <p>The ports are electrically isolated from the scanner.</p> <p>The IO/standard is LVTTTL (0 V...3.3 V) without external power supply and TTL (0 V...5 V) with an external power supply.</p>
Sync Out 50 Ohm 1 Sync Out 50 Ohm 2	<p>Sync Out 50 Ohm 1 / 2 put out the same signal as Sync Out 1/2.</p> <p>They have the capability to drive 50 Ohm loads.</p> <p>The ports are electrically isolated from the scanner.</p>
Sync Out NIM 1 Sync Out NIM 2	<p>Output of the selected Sync In signal. NIM standard.</p> <p>Output of the selected Sync Out 1 NIM standard.</p>
Sync In 1 Sync In 2	<p>Input signals for synchronizing the scanner with an MP laser.</p>
Trigger In 1 Trigger In 2	<p>Inputs for external trigger signals.</p> <p>The sampling rate of these ports is 1 MHz.</p> <p>The IO/standard is LVTTTL (0 V...3.3 V) with no external power supply and TTL (0 V...5 V) with an external power supply.</p>
Optional Trigger I/O	
Internal Connector J6	
Scan head / Trigger box	<p>Connection to the scan head.</p>

II. Connectors and explanations

Naming on Trigger Unit	Application/Use	E-Phys Assignment/Use → connection at DAQ Box
Sync In 1 / 50 Ohm (SMB)	not in use	
Sync In 2 / 50 Ohm (SMB)	not in use	
Trigger In 1 (SMB)	LDM in	Trigger in 1
Trigger In 2 (SMB)	LDM/FCS in	Trigger in 2
Trigger Out 1 (SMB)	LDM out 1	EP out 1
Trigger Out 2 (SMB)	LDM out 2	EP out 2
Trigger Out 3 (SMB)	LDM out 3	EP out 3
Trigger Out 4 (SMB)	LDM out 4	EP out 4
Trigger Out 5 (SMB)	FCS trigger out	Sample clock → connect to "CTR 0 OUT"
Trigger Out 6 (SMB)	Frame trigger (FLIM trigger)	Frame trigger
Trigger Out 7 (SMB)	Line trigger (FLIM trigger)	Line trigger
Trigger Out 8 (SMB)	Frame trigger (for ROI spectrometer)	Data Acquisition Start → connect to "AI START"
Sync Out 1 (SMB)	Pixel enable* (FLIM trigger)	for short wiring
Sync Out 2 (SMB)	Pixel clock 40 MHz (clock generator)	for short wiring
Sync Out 1 / NIM (BNC) **	not DC isolated	
Sync Out 2 / NIM (BNC) ***	not DC isolated	
Sync Out 1 / 50 Ohm (BNC) **	Pixel enable (FLIM trigger)	
Sync Out 2 / 50 Ohm (BNC) ***	Pixel clock 40 MHz	

** Synch Out 1 (SMB) and Synch Out 1 / 50 Ohm (BNC) are connected parallel;

*** Synch Out 2 (SMB) and Synch Out 2 / 50 Ohm (BNC) are connected parallel.

For SMB use 50 Ohm.

Freely configurable triggers in LAS AF Trigger Settings window

Trigger In 1 and 2

Trigger Out 1 to 4

Optional Trigger I/O: input trigger 3 to 6

Triggers that can be used to monitor the scanning process by LAS AF via the Data Acquisition Box by National Instruments or oscilloscope:

Trigger Out 6 (frame trigger)

Trigger Out 7 (line trigger)

“With the user, for the user”

Leica Microsystems

Leica Microsystems operates globally in four divisions, where we rank with the market leaders.

• Life Science Division

The Leica Microsystems Life Science Division supports the imaging needs of the scientific community with advanced innovation and technical expertise for the visualization, measurement, and analysis of microstructures. Our strong focus on understanding scientific applications puts Leica Microsystems' customers at the leading edge of science.

• Industry Division

The Leica Microsystems Industry Division's focus is to support customers' pursuit of the highest quality end result. Leica Microsystems provide the best and most innovative imaging systems to see, measure, and analyze the microstructures in routine and research industrial applications, materials science, quality control, forensic science investigation, and educational applications.

• Biosystems Division

The Leica Microsystems Biosystems Division brings histopathology labs and researchers the highest-quality, most comprehensive product range. From patient to pathologist, the range includes the ideal product for each histology step and high-productivity workflow solutions for the entire lab. With complete histology systems featuring innovative automation and Novocastra™ reagents, Leica Microsystems creates better patient care through rapid turnaround, diagnostic confidence, and close customer collaboration.

• Medical Division

The Leica Microsystems Medical Division's focus is to partner with and support surgeons and their care of patients with the highest-quality, most innovative surgical microscope technology today and into the future.

The statement by Ernst Leitz in 1907, “with the user, for the user,” describes the fruitful collaboration with end users and driving force of innovation at Leica Microsystems. We have developed five brand values to live up to this tradition: Pioneering, High-end Quality, Team Spirit, Dedication to Science, and Continuous Improvement. For us, living up to these values means: **Living up to Life.**

Active worldwide

Australia:	North Ryde	Tel. +61 2 8870 3500	Fax +61 2 9878 1055
Austria:	Vienna	Tel. +43 1 486 80 50 0	Fax +43 1 486 80 50 30
Belgium:	Groot Bijgaarden	Tel. +32 2 790 98 50	Fax +32 2 790 98 68
Canada:	Concord/Ontario	Tel. +1 800 248 0123	Fax +1 847 236 3009
Denmark:	Ballerup	Tel. +45 4454 0101	Fax +45 4454 0111
France:	Nanterre Cedex	Tel. +33 811 000 664	Fax +33 1 56 05 23 23
Germany:	Wetzlar	Tel. +49 64 41 29 40 00	Fax +49 64 41 29 41 55
Italy:	Milan	Tel. +39 02 574 861	Fax +39 02 574 03392
Japan:	Tokyo	Tel. +81 3 5421 2800	Fax +81 3 5421 2896
Korea:	Seoul	Tel. +82 2 514 65 43	Fax +82 2 514 65 48
Netherlands:	Rijswijk	Tel. +31 70 4132 100	Fax +31 70 4132 109
People's Rep. of China:	Hong Kong	Tel. +852 2564 6699	Fax +852 2564 4163
	Shanghai	Tel. +86 21 6387 6606	Fax +86 21 6387 6698
Portugal:	Lisbon	Tel. +351 21 388 9112	Fax +351 21 385 4668
Singapore		Tel. +65 6779 7823	Fax +65 6773 0628
Spain:	Barcelona	Tel. +34 93 494 95 30	Fax +34 93 494 95 32
Sweden:	Kista	Tel. +46 8 625 45 45	Fax +46 8 625 45 10
Switzerland:	Heerbrugg	Tel. +41 71 726 34 34	Fax +41 71 726 34 44
United Kingdom:	Milton Keynes	Tel. +44 800 298 2344	Fax +44 1908 246312
USA:	Buffalo Grove/Illinois	Tel. +1 800 248 0123	Fax +1 847 236 3009

and representatives in more than 100 countries